

 [www.carlack.com.pl](http://www.carlack.com.pl)



KATALOG FRONTÓW LAKIEROWANYCH

 71 383 45 45

 [biuro@carlack.com.pl](mailto:biuro@carlack.com.pl)

**CARLACK**  
fronty meblowe

 ul. Leśna 6  
56-321 Bukowice



# CARLACK

fronty meblowe

- ◀ CARLACK to prywatne przedsiębiorstwo istniejące od 1999 roku.
- ◀ Specjalizujemy się w produkcji frontów oraz komponentów meblowych.
- ◀ Posiadamy własną mieszalnię farb i lakierów.
- ◀ Wieloletnie doświadczenie pracowników przy produkcji elementów meblowych zapewnia najwyższą jakość produktów.
- ◀ Nasze technologie są stale udoskonalane. Dążymy, aby nasze produkty były zgodne z obowiązującymi standardami.
- ◀ Nasza firma jest ciągle modernizowana tak, aby dostosowywać się do potrzeb i oczekiwań klientów.

**Zapraszamy do współpracy!**



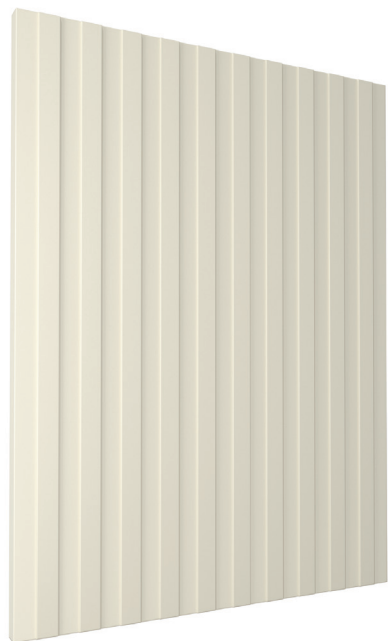

### LAMELKA L-1

GŁĘBOKOŚĆ WYBRANIA - 3 mm

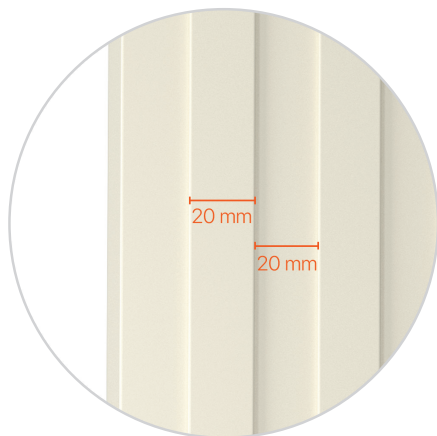

### LAMELKA L-2

GŁĘBOKOŚĆ WYBRANIA - 3 mm

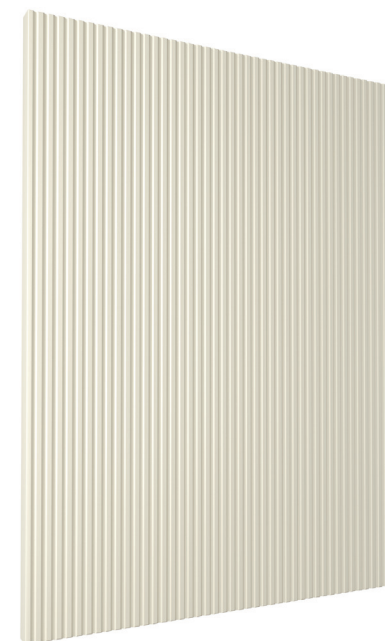
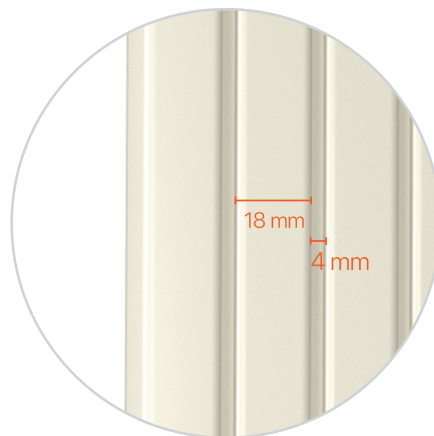

### LAMELKA L-3

GŁĘBOKOŚĆ WYBRANIA - 2 mm

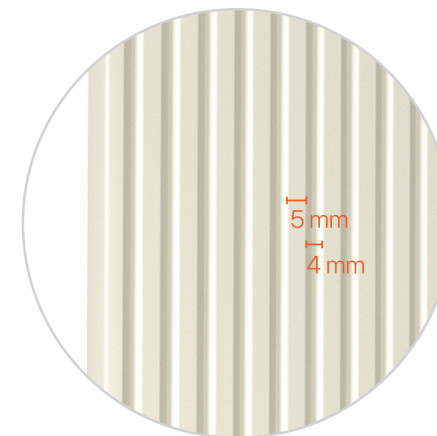



### LAMELKA L-4

GŁĘBOKOŚĆ WYBRANIA - 3 mm

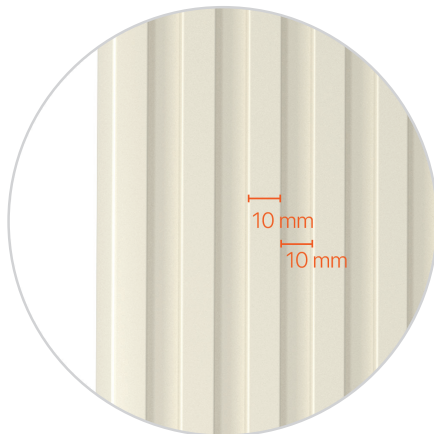

### LAMELKA L-5

GŁĘBOKOŚĆ WYBRANIA - 6 mm  
STANDARDOWA GRUBOŚĆ - 22 mm

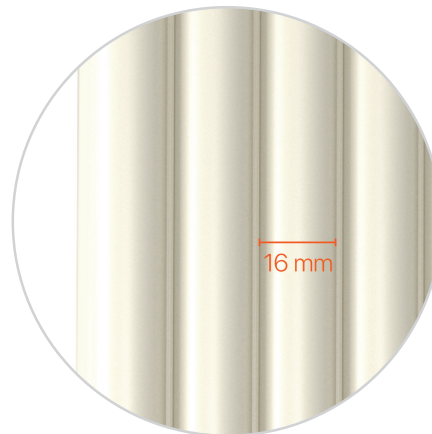

### JODEŁKA

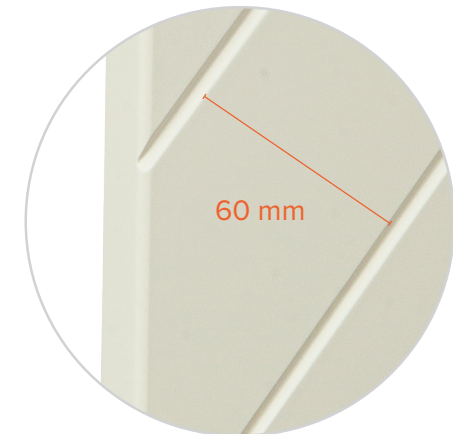



FRONTY  
RAMOWE

MBS/R2

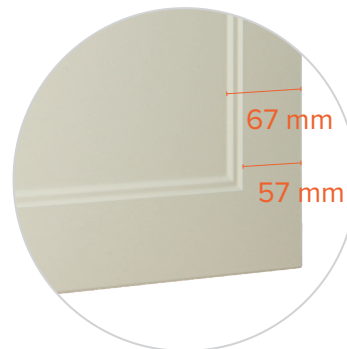

BARSAK/R2

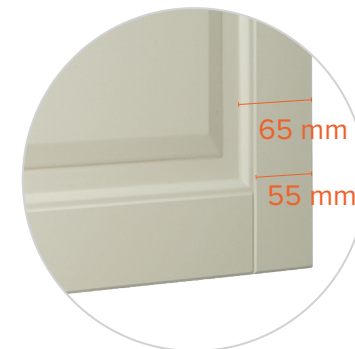



P/5/R2

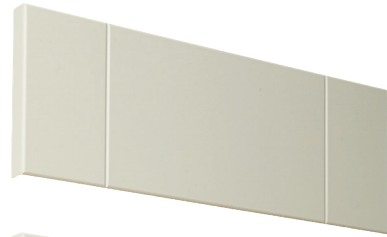

PR/6/R2



PR/9/R2

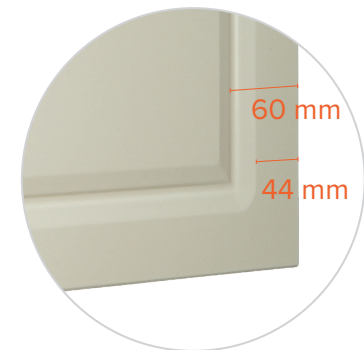



PR/10/R2

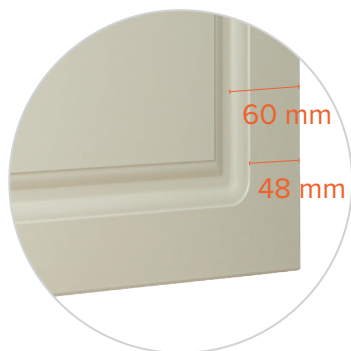

PR/11/R2



PR/20/R2

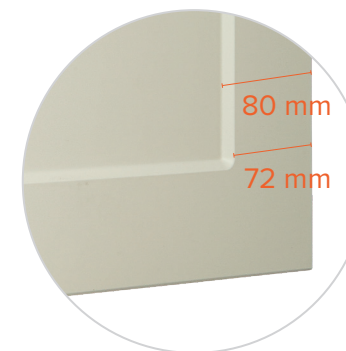



**PR/21/R2**

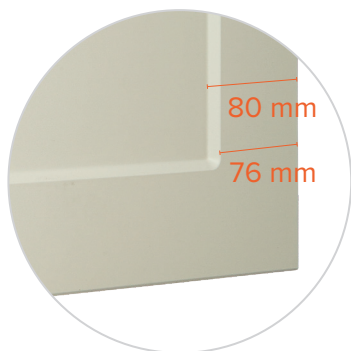

**PR/33/R2**

STANDARDOWA SZEROKOŚĆ  
RAMY WITRYNY - 60 mm

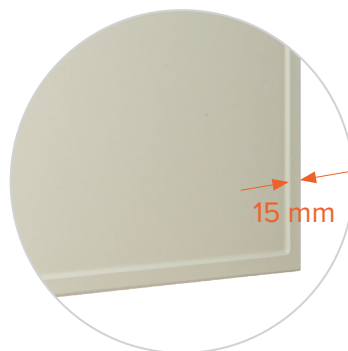

**PR/50/R2**

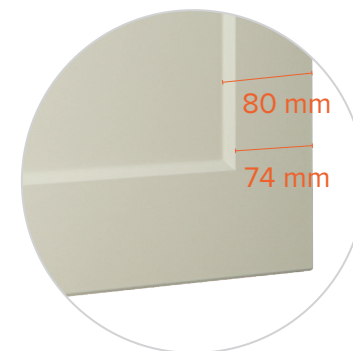

PR/51/R2

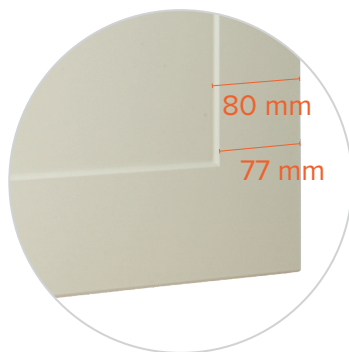

GLOBAL/R2

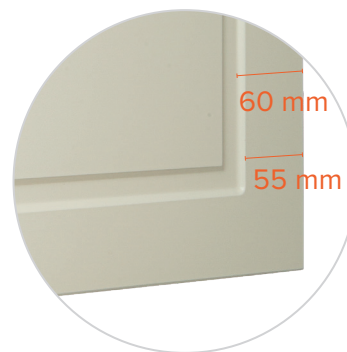

AVINA/R2

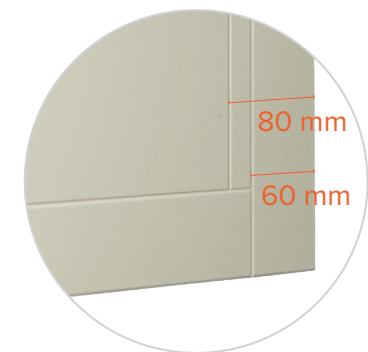



LOTUS/R2

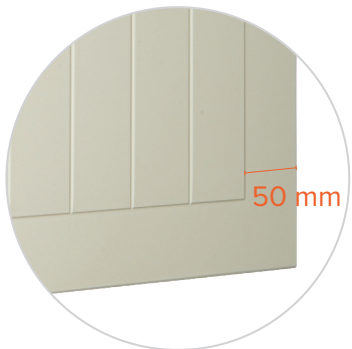

MEFO/R2

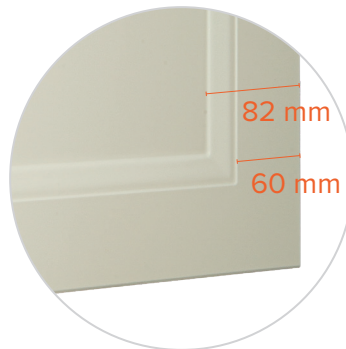

S1/RAJO/R2

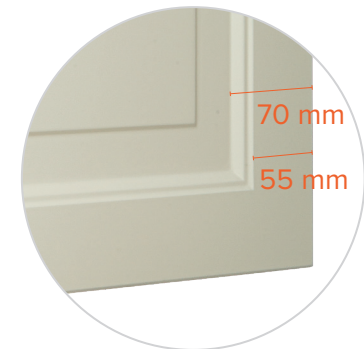

P/3/MSM



GRZEŚ/R2

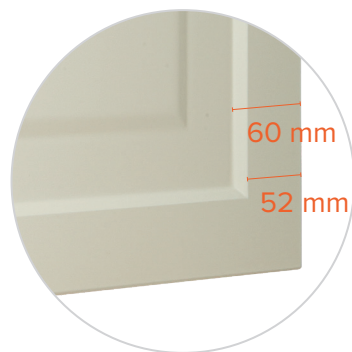

MEGAN/R2

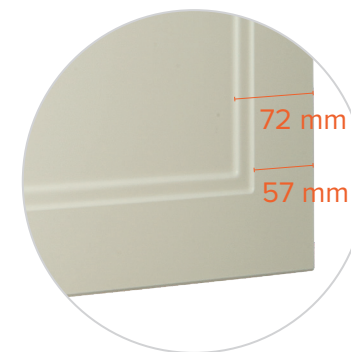



**MARYSIA/R2**

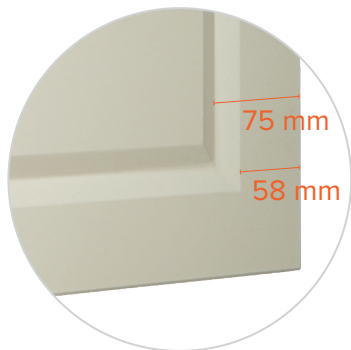

**RAMONA/R2**

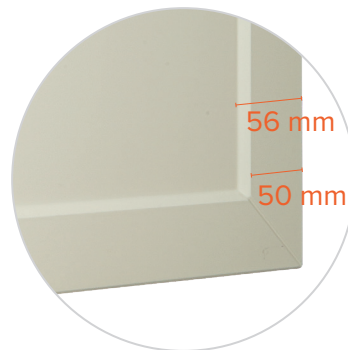
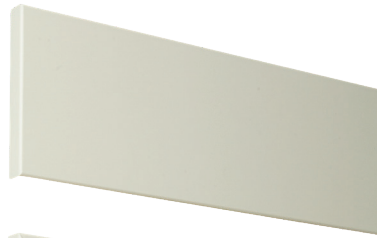

**KEG/R2**  
STANDARDOWA GRUBOŚĆ: 22 mm

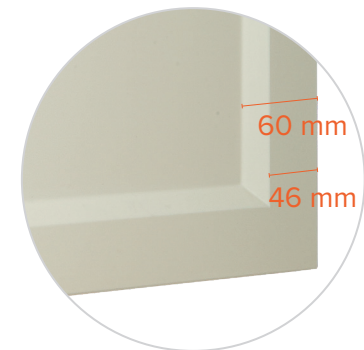

# WITRYNY

## WITRYNA W1





WITRYNA W2

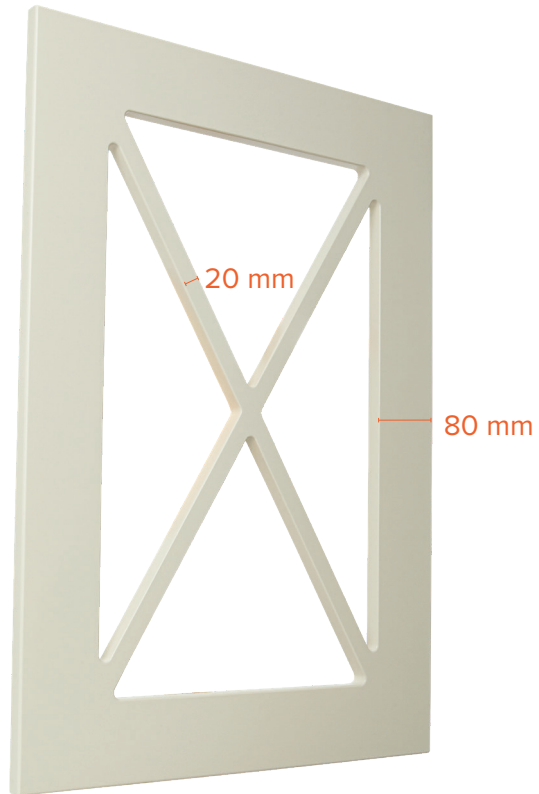

WITRYNA W3\*

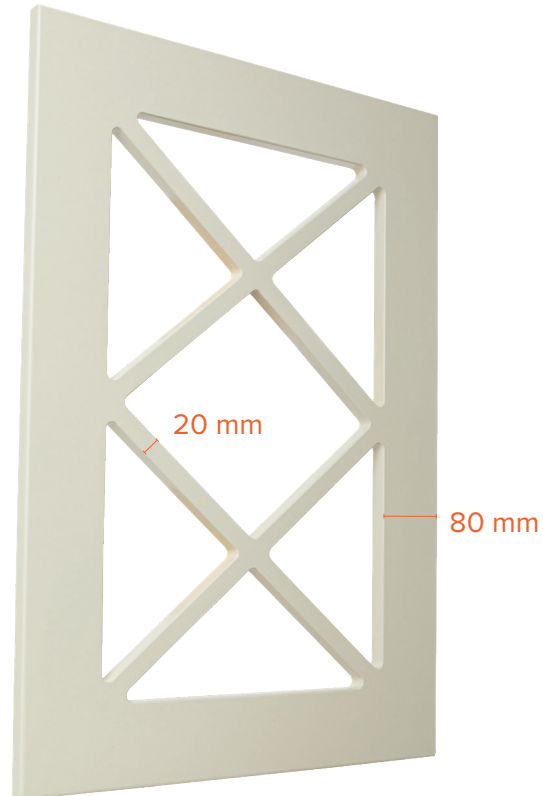

WITRYNA W4\*

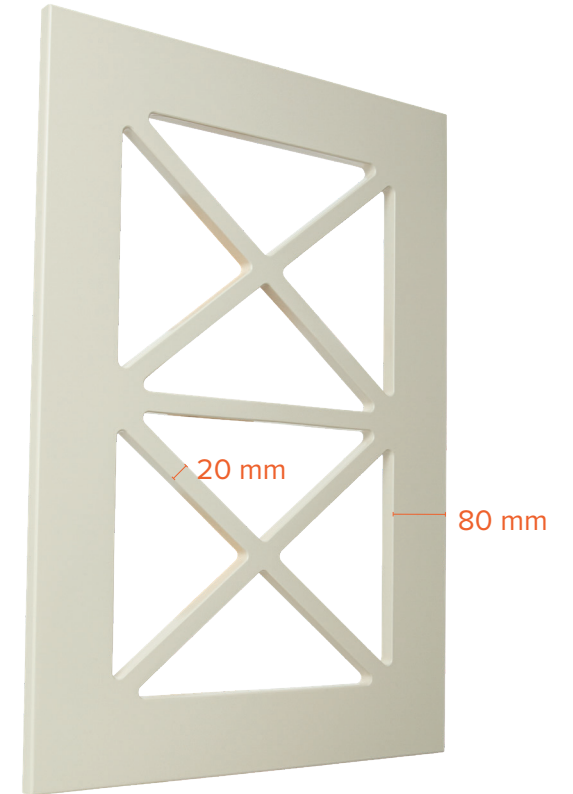

WITRYNA W5\*

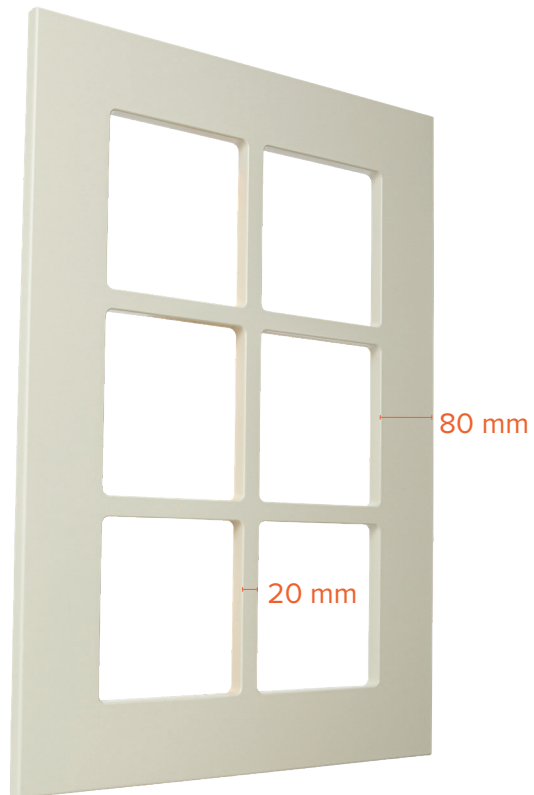

WITRYNA W6\*

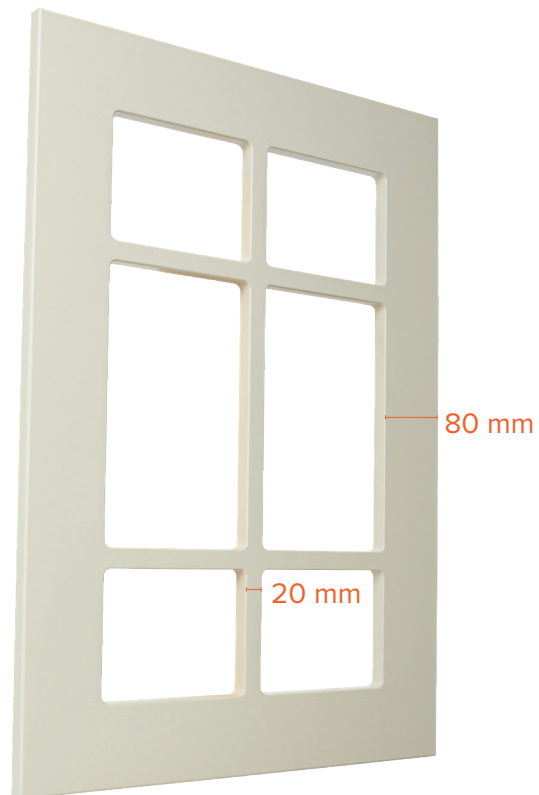

WITRYNA W7

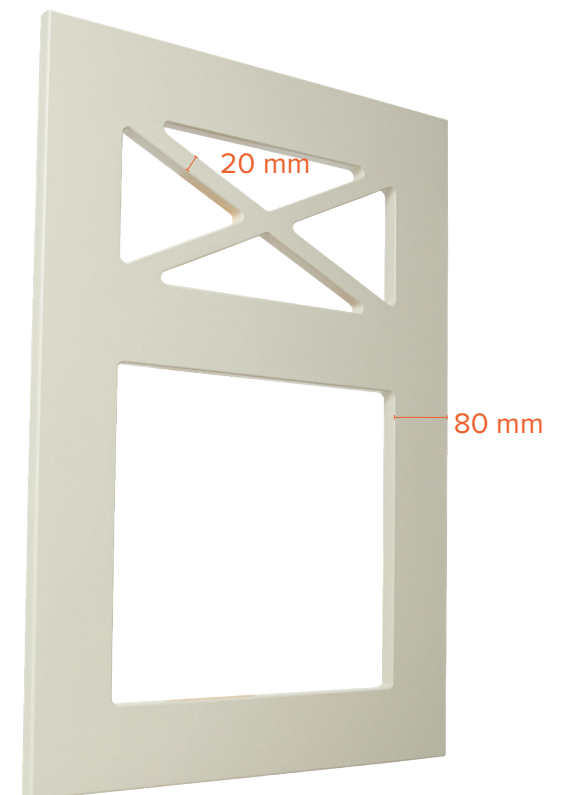

\*- zdjęcie poglądowe. Przy składaniu zamówienia należy podać ilość okienek.



UCHWYTY  
FREZOWANE

UCHWYT „A”

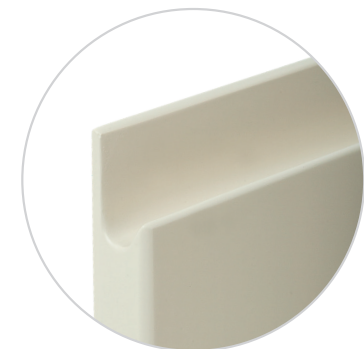

UCHWYT „B”

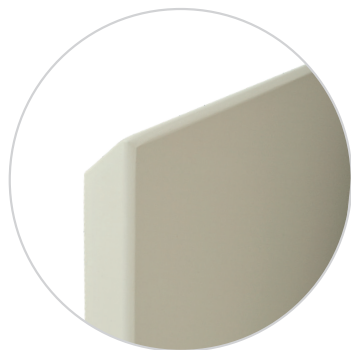

UCHWYT „C”



UCHWYT „E”



UCHWYT „F”



UCHWYT „UKW5”

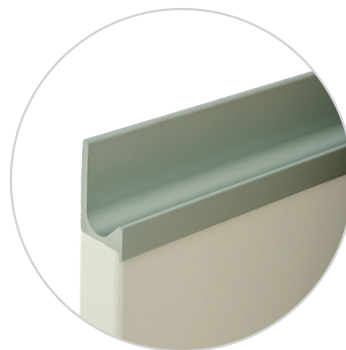

UCHWYT „UKW7”

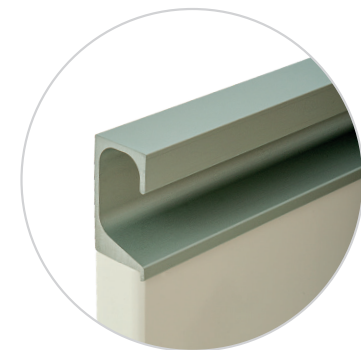



PILASTRY  
LISTWY  
WIEŃCZĄCE

PILASTER P1



PILASTER P2



PILASTER P3



**LISTWA LW13**

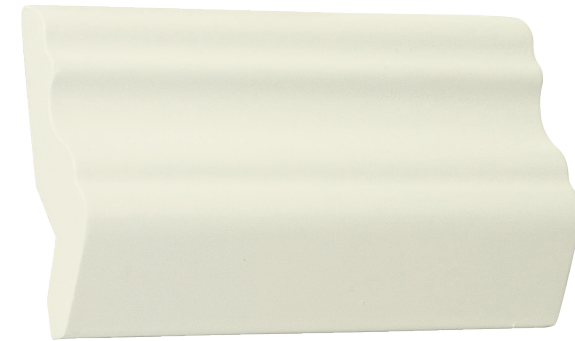
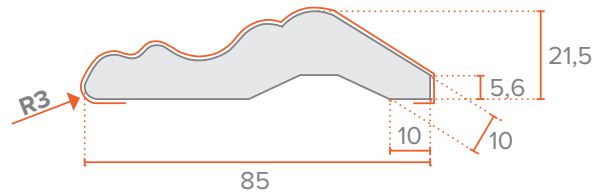

**LISTWA LW16**

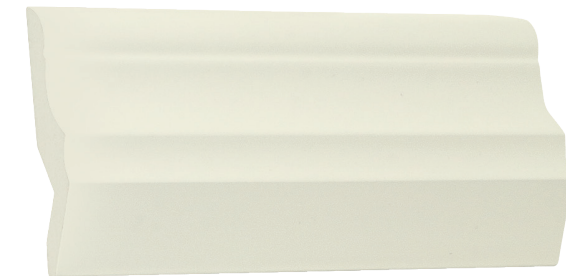
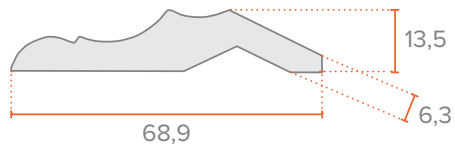

**LISTWA LW25**

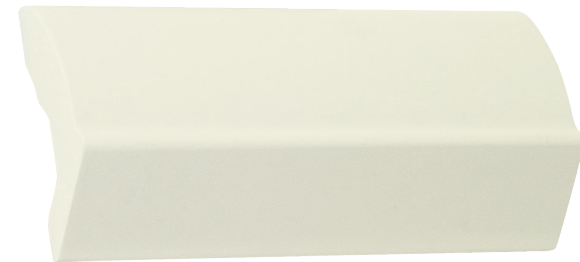
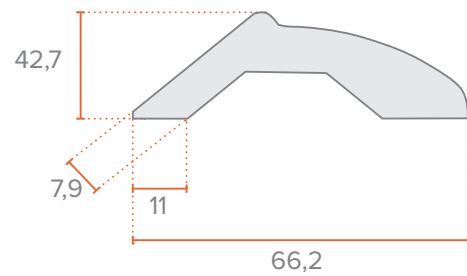

**LISTWA LW27**

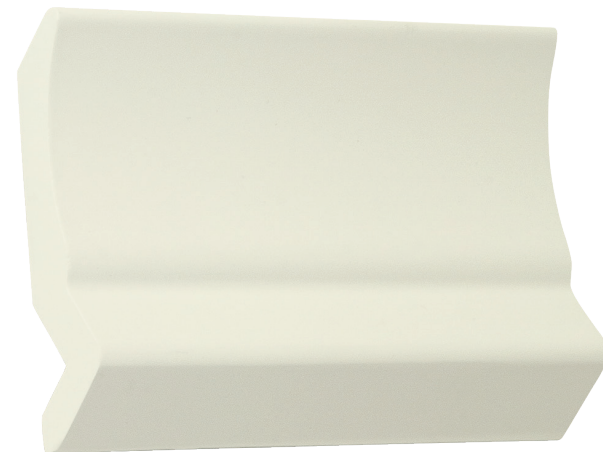
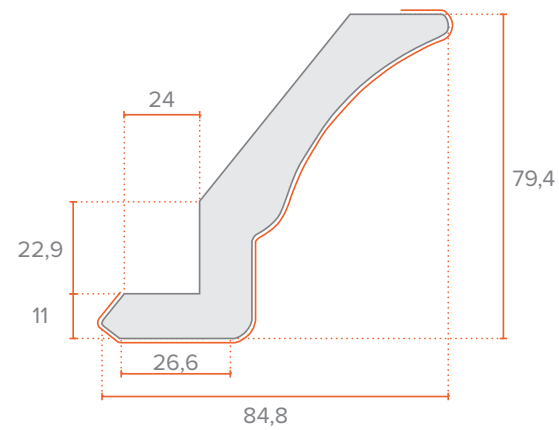
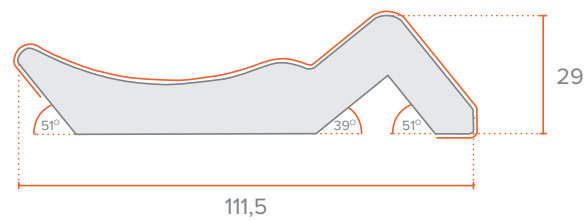



## INFORMACJE TECHNICZNE

- ◀ Pracujemy na wzornikach - **RAL K7, NCS, ICA.**
- ◀ Standardowa grubość frontów wynosi **18 mm.**
- ◀ Dostępne grubości w MDF:  
**10 mm, 16 mm, 18 mm, 22 mm, 28 mm, 38 mm, 50 mm.**
- ◀ Uchwyt występuje **w standardzie po szerokości.**  
Uchwyt frezowany wykonujemy na płycie o grubości **18 mm.**
- ◀ Dostępne dwa wykończenia powłok: **połysk, mat.**  
Brak określenia, skutkuje wykonaniem **w połysku.**
- ◀ Standardowa krawędź frontów gładkich i ramiakowych to **R2.**  
Możliwość indywidualnego doboru frezowania.  
Frezy obwiedniowe do wyboru: R1, R2, R5, R10, M, MS2, MS5, MSM.
- ◀ Dostępny **maksymalny wymiar** frontu, wykonanego przy użyciu maszyny CNC wynosi **2800x1200 mm.**
- ◀ Wszystkie zamówienia powinny być rozpisywane na naszym oryginalnym arkuszu zamówieniowym. Klienci, którzy nie stosują się do powyższego, muszą liczyć się z faktem, iż w przypadku błędnego przepisania zamówienia przez dział handlowy, ewentualna reklamacja nie będzie uwzględniona.
- ◀ Przy lakierowaniu lewej strony matem, niemożliwe jest wykonanie zaoblenia krawędzi.



### Dział sprzedaży

tel./fax **71 383 45 45**

tel. kom. 600 599 044    joanna@carlack.com.pl

tel. kom. 664 768 869    agnieszka@carlack.com.pl

### Dział reklamacji

tel. kom. 530 554 020    reklamacje@carlack.com.pl

Pełna oferta firmy znajduje się na **www.carlack.com.pl**



**ul. Leśna 6, 56-321 Bukowice**

**Godziny otwarcia:** Pn.-Pt. 7:00-15:00.

**Zapraszamy!**



NINIEJSZA INFORMACJA NIE STANOWI OFERTY HANDLOWEJ W ROZUMIENIU KC.  
PRODUCENT ZASTRZEGA SOBIE PRAWO DO WPROWADZENIA ZMIAN BEZ UPRIEDNIEGO O NICH POINFORMOWANIA ZAINTERESOWANYCH STRON.

